



SPECIFICATIONS & SIZES

RICHVALEYORK.COM



100% CANADIAN OWNED

At Richvale York, we set the highest standards for every Block, Brick or Stone that we make.

With over 65 years of experience we know our industry – inside and out.

To satisfy the needs of our clients – Architects, Developers, Masonry Contractors and Builders, we provide an array of possibilities. Whatever your profession, you'll be proud to associate with us.
Distributing Coast - to - Coast

Our state-of-the-art production facilities enable us to meet your toughest deadlines. We also maintain an extensive inventory to ensure that all of your requirements are met without compromise.

Leading the block industry as manufacturers of the UltraLite, Lightweight, Concrete, Architectural, Stone and Ground Face, Richvale York Block Inc. is committed to being its clients producer of choice.

We invite you to benefit from Richvale York's qualified personnel, superior products and service. Please accept our invitation by requesting more information about our value added product lines. Contact us at our Sales, Marketing or Technical Service Departments.















NEW PRODUCTS • MORE SELECTION

VISIT US AT RICHVALEYORK.COM

PROUD MEMBERS OF









| STANDARD BLOCK | | | 10 cm | 15 cm | 20 cm | 25 cm | 30 cm |
|------------------------------|-------------------------------------------------------------------------------------|--------------------------------------------------------------------------------------------------------|------------------------------------------------------------------------------------|-------------------------------------------|------------------------------|-------|-------|
| STRETCHER |  | Concrete Normal Lightweight Concrete 2hr. Fire Rating Lightweight 2hr. Fire Rating Cartage | | | | | |
| BULLNOSED SINGLE/DOUBLE FACE |  | Concrete Normal Lightweight Cartage | | | | | |
| BULLNOSED SINGLE/DOUBLE HALF |  | Concrete Normal Lightweight Cartage | | | | | |
| "A" BLOCK |  | Concrete Normal Lightweight Cartage | | | | | |
| ASHLAR STRETCHER |  | Concrete Normal Lightweight Cartage | | | | | |
| W - BLOCK |  | BOND BEAM (LINTEL) |  | Concrete Normal Lightweight Cartage | | | |
| SEMI SOLID (CAP) |  | Concrete Normal Lightweight Cartage | | | | | |
| SOLID - 75% |  | Concrete Normal Lightweight Cartage | | | | | |
| SOLID - 100% |  | Concrete Normal Lightweight Cartage | | | | | |
| PIER SASH/UNIVERSAL |  | Concrete Normal Lightweight Cartage | | | | | |
| PIER SASH HALF |  | Concrete Normal Lightweight Cartage | | | | | |
| L-CORNER |  | Concrete Normal Lightweight Cartage | | | | | |
| SPLAY CORNER |  | Concrete Normal Lightweight Cartage | | | | | |
| SOLID SLAB 5 x 20 x 40cm | PILASTERS 40.5 x 20 x 48.5cm | | BACK UP BRICK | | CHIMNEY BLOCK 20 x 20 x 40cm | | |

PRICES ARE AVAILABLE
UPON REQUEST, FOR
FURTHER INFORMATION
PLEASE CALL



1.877.792.5625



| STANDARD BLOCK | | | 10 cm | 15 cm | 20 cm | 25 cm | 30 cm |
|---------------------------------------------------------------------------------------------------------------------------------------|----------------------------------------------------------------------------------------------|-----------------------------------------------------------------------------------------------------------------------------------------------------------------------------------------------|----------------------------------------------------------------------|------------------------------------------------------------------------------------|-------|-------|-------|
| SPLIT FACE 2, 3, 4 & 6 RIB SPLIT FLUTED LEDGE  | Concrete Grey Concrete Colour Pastel Colour Diamond Black / Arctic White Cartage | <p style="text-align: center;">PRICES ARE AVAILABLE UPON REQUEST, FOR FURTHER INFORMATION PLEASE CALL:</p> <p style="text-align: center;"><u>1.877.792.5625</u></p> | | | | | |
| L-CORNER  | Concrete Grey Concrete Colour Pastel Colour Diamond Black / Arctic White Cartage | | | | | | |
| SCORED  | Concrete Grey Concrete Colour Diamond Black / Arctic White Cartage | | | | | | |
| L-CORNER  | Concrete Grey Concrete Colour Diamond Black / Arctic White Cartage | | | | | | |
| STANDARD AND ARCHITECTURAL COLOURS | | | | | | | |
| Concrete Colours | | | | Pastels Colours | | | |
| Autumn Red - Bronze - Cedar Tan Chestnut - Exec. Brown - Golden Buff Light Grey - Salmon - Walnut | | | | Champagne, Simcoe Dark Charcoal, Pearl Grey Cream, Ivory - Spring Tan, Huron | | | |
| PREMIUMS FOR SMOOTH CONCRETE COLOURED BLOCKS | | | 10 cm | 15 cm | 20 cm | 25 cm | 30 cm |
| Concrete Colours | | | <p style="text-align: center;">PRICES ARE AVAILABLE UPON REQUEST</p> | | | | |
| Pastels Colours | | | | | | | |
| Arctic White / Midnight Black / Diamond Black | | | | | | | |
| HIGH STRENGTH BLOCK | | | 10 cm | 15 cm | 20 cm | 25 cm | 30 cm |
| 20MPa Premium (Additional) | | | <p style="text-align: center;">PRICES ARE AVAILABLE UPON REQUEST</p> | | | | |
| 25MPa Premium (Additional) | | | | | | | |
| 30MPa Premium (Additional) | | | | | | | |
| Dry Block Additive | | | | | | | |
| CARBON CAPTURE BLOCK | | | 10 cm | 15 cm | 20 cm | 25 cm | 30 cm |
| Concrete | | | <p style="text-align: center;">PRICES ARE AVAILABLE UPON REQUEST</p> | | | | |
| Lightweight | | | | | | | |
| Cartage | | | | | | | |
| ACOUSTIC BLOCK | | | 10 cm | 15 cm | 20 cm | 25 cm | 30 cm |
| ACOUSTADE™  | Lightweight Cartage | <p style="text-align: center;">PRICES ARE AVAILABLE UPON REQUEST</p> | | | | | |
| SOUND CELL™  | Lightweight Cartage | | | | | | |

SLIGHT VARIANCES IN SHADING MAY OCCUR.

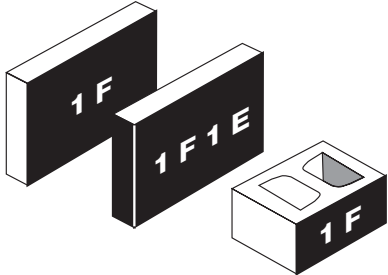

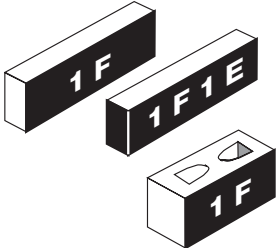
| CAMBRIDGE SERIES GROUND FACE, CHISELED OR STIPPLED | | Description | Dimensions(cm) D x H x L | Colour | | | | | | | | | | | | | | | | | | | | | | | | | | |
|---------------------------------------------------------------------------------------------------------------------------------------------------------------------------------------------------------------------------------------------------------------------------------------------------------------------------------------------------------------------------------------------------------------------------------------------------------------------------------------------------------------------------------------------------------------------------------------------------------------------------------------------------------------------|----------------------|------------------------|-----------------------------|------------------|-----------------|------|--------|------------|-------|--|------------|---------|-------|-------|-----------|--|----------|---------|---------|-----------|----------|--|--------|--|------------|--|--|-------------|--------------|-----------------|
| Standard  | | Standard (1F) | 10 x 20 x 40 | Standard Colours | | | | | | | | | | | | | | | | | | | | | | | | | | |
| | | Standard (1F) | 10 x 20 x 60 | | | | | | | | | | | | | | | | | | | | | | | | | | | |
| | | Standard (1F) | 10 x 30 x 60 | | | | | | | | | | | | | | | | | | | | | | | | | | | |
| | | Standard (1F) | 15 x 20 x 40 | | | | | | | | | | | | | | | | | | | | | | | | | | | |
| | | Standard (1F) | 20 x 20 x 40 | | | | | | | | | | | | | | | | | | | | | | | | | | | |
| | | Standard (1F) | 25 x 20 x 40 | | | | | | | | | | | | | | | | | | | | | | | | | | | |
| | | Standard (1F) | 30 x 20 x 40 | | | | | | | | | | | | | | | | | | | | | | | | | | | |
| | | Standard (1F) | 10 x 40 x 60 | | | | | | | | | | | | | | | | | | | | | | | | | | | |
| | | Standard "L" Corner | 10 x 20 x 20 x 40 | | | | | | | | | | | | | | | | | | | | | | | | | | | |
| | | Standard Corner (1F1E) | 10 x 20 x 60 | | | | | | | | | | | | | | | | | | | | | | | | | | | |
| | | Standard Corner (1F1E) | 10 x 30 x 60 | | | | | | | | | | | | | | | | | | | | | | | | | | | |
| L Corner  | | Standard (1F) | 10 x 20 x 40 | Premier Colours | | | | | | | | | | | | | | | | | | | | | | | | | | |
| | | Standard (1F) | 10 x 20 x 60 | | | | | | | | | | | | | | | | | | | | | | | | | | | |
| | | Standard (1F) | 10 x 30 x 60 | | | | | | | | | | | | | | | | | | | | | | | | | | | |
| | | Standard (1F) | 15 x 20 x 40 | | | | | | | | | | | | | | | | | | | | | | | | | | | |
| | | Standard (1F) | 20 x 20 x 40 | | | | | | | | | | | | | | | | | | | | | | | | | | | |
| | | Standard (1F) | 25 x 20 x 40 | | | | | | | | | | | | | | | | | | | | | | | | | | | |
| | | Standard (1F) | 30 x 20 x 40 | | | | | | | | | | | | | | | | | | | | | | | | | | | |
| | | Standard (1F) | 10 x 40 x 60 | | | | | | | | | | | | | | | | | | | | | | | | | | | |
| | | Standard "L" Corner | 10 x 20 x 20 x 40 | | | | | | | | | | | | | | | | | | | | | | | | | | | |
| | | Standard Corner (1F1E) | 10 x 20 x 60 | | | | | | | | | | | | | | | | | | | | | | | | | | | |
| | | Standard Corner (1F1E) | 10 x 30 x 60 | | | | | | | | | | | | | | | | | | | | | | | | | | | |
| Ashlar  | | Ashlar (1F) | 10 x 10 x 40 | Standard Colours | | | | | | | | | | | | | | | | | | | | | | | | | | |
| | | Ashlar (1F) | 15 x 10 x 40 | | | | | | | | | | | | | | | | | | | | | | | | | | | |
| | | Ashlar (1F) | 20 x 10 x 40 | | | | | | | | | | | | | | | | | | | | | | | | | | | |
| | | Ashlar (1F) | 25 x 10 x 40 | | | | | | | | | | | | | | | | | | | | | | | | | | | |
| | | Ashlar (1F) | 30 x 10 x 40 | | | | | | | | | | | | | | | | | | | | | | | | | | | |
| | | Ashlar (1F) | 10 x 10 x 60 | | | | | | | | | | | | | | | | | | | | | | | | | | | |
| | | Ashlar (1F) | 15 x 10 x 60 | | | | | | | | | | | | | | | | | | | | | | | | | | | |
| | | Ashlar (1F) | 20 x 10 x 60 | | | | | | | | | | | | | | | | | | | | | | | | | | | |
| | | Ashlar (1F) | 25 x 10 x 60 | | | | | | | | | | | | | | | | | | | | | | | | | | | |
| | | Ashlar (1F) | 30 x 10 x 60 | | | | | | | | | | | | | | | | | | | | | | | | | | | |
| | | Ashlar Corner (1F1E) | 10 x 10 x 40 | | | | | | | | | | | | | | | | | | | | | | | | | | | |
| | Ashlar Corner (1F1E) | 10 x 10 x 60 | | | | | | | | | | | | | | | | | | | | | | | | | | | | |
| <table border="1"> <thead> <tr> <th>Standard Colours</th> <th>Premier Colours</th> </tr> </thead> <tbody> <tr> <td>Beige</td> <td>Arctic White</td> </tr> <tr> <td>Executive Brown</td> <td>Onyx</td> </tr> <tr> <td>Carmel</td> <td>Pearl Grey</td> </tr> <tr> <td>Cream</td> <td></td> </tr> <tr> <td>Dover Grey</td> <td>Diamond</td> </tr> <tr> <td>Huron</td> <td>Black</td> </tr> <tr> <td>Lancaster</td> <td></td> </tr> <tr> <td>Larkspur</td> <td>Diamond</td> </tr> <tr> <td>Redwood</td> <td>Black - 3</td> </tr> <tr> <td>Richmond</td> <td></td> </tr> <tr> <td>Simcoe</td> <td></td> </tr> <tr> <td>Wellington</td> <td></td> </tr> </tbody> </table> | Standard Colours | Premier Colours | Beige | Arctic White | Executive Brown | Onyx | Carmel | Pearl Grey | Cream | | Dover Grey | Diamond | Huron | Black | Lancaster | | Larkspur | Diamond | Redwood | Black - 3 | Richmond | | Simcoe | | Wellington | | | Ashlar (1F) | 10 x 10 x 40 | Premier Colours |
| | Standard Colours | Premier Colours | | | | | | | | | | | | | | | | | | | | | | | | | | | | |
| | Beige | Arctic White | | | | | | | | | | | | | | | | | | | | | | | | | | | | |
| | Executive Brown | Onyx | | | | | | | | | | | | | | | | | | | | | | | | | | | | |
| | Carmel | Pearl Grey | | | | | | | | | | | | | | | | | | | | | | | | | | | | |
| | Cream | | | | | | | | | | | | | | | | | | | | | | | | | | | | | |
| | Dover Grey | Diamond | | | | | | | | | | | | | | | | | | | | | | | | | | | | |
| | Huron | Black | | | | | | | | | | | | | | | | | | | | | | | | | | | | |
| | Lancaster | | | | | | | | | | | | | | | | | | | | | | | | | | | | | |
| | Larkspur | Diamond | | | | | | | | | | | | | | | | | | | | | | | | | | | | |
| | Redwood | Black - 3 | | | | | | | | | | | | | | | | | | | | | | | | | | | | |
| Richmond | | | | | | | | | | | | | | | | | | | | | | | | | | | | | | |
| Simcoe | | | | | | | | | | | | | | | | | | | | | | | | | | | | | | |
| Wellington | | | | | | | | | | | | | | | | | | | | | | | | | | | | | | |
| | | Ashlar (1F) | 15 x 10 x 40 | | | | | | | | | | | | | | | | | | | | | | | | | | | |
| | | Ashlar (1F) | 20 x 10 x 40 | | | | | | | | | | | | | | | | | | | | | | | | | | | |
| | | Ashlar (1F) | 25 x 10 x 40 | | | | | | | | | | | | | | | | | | | | | | | | | | | |
| | | Ashlar (1F) | 30 x 10 x 40 | | | | | | | | | | | | | | | | | | | | | | | | | | | |
| | | Ashlar (1F) | 10 x 10 x 60 | | | | | | | | | | | | | | | | | | | | | | | | | | | |
| | | Ashlar (1F) | 15 x 10 x 60 | | | | | | | | | | | | | | | | | | | | | | | | | | | |
| | | Ashlar (1F) | 20 x 10 x 60 | | | | | | | | | | | | | | | | | | | | | | | | | | | |
| | | Ashlar (1F) | 25 x 10 x 60 | | | | | | | | | | | | | | | | | | | | | | | | | | | |
| | | Ashlar (1F) | 30 x 10 x 60 | | | | | | | | | | | | | | | | | | | | | | | | | | | |
| | | Ashlar Corner (1F1E) | 10 x 10 x 40 | | | | | | | | | | | | | | | | | | | | | | | | | | | |
| | | Ashlar Corner (1F1E) | 10 x 10 x 60 | | | | | | | | | | | | | | | | | | | | | | | | | | | |
| LEGEND (1F) ONE FACE FINISHED (1F1E) ONE FACE ONE END FINISHED | | | | | | | | | | | | | | | | | | | | | | | | | | | | | | |

OTHER CAMBRIDGE SERIES PRODUCT SIZES AVAILABLE UPON REQUEST SLIGHT VARIANCES IN SHADING MAY OCCUR



CAMBRIDGE ARCHITECTURAL SILLS PROFILES & SIZES

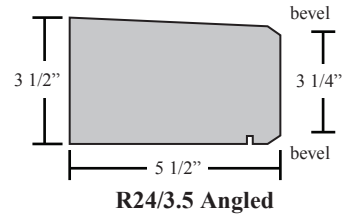
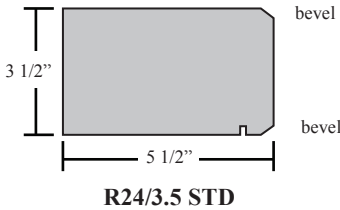
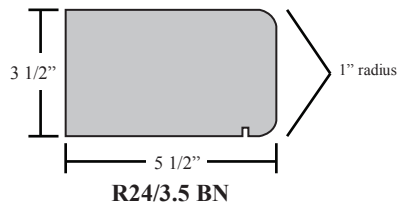
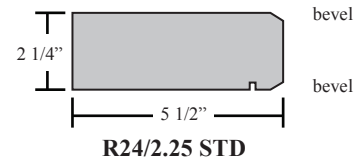
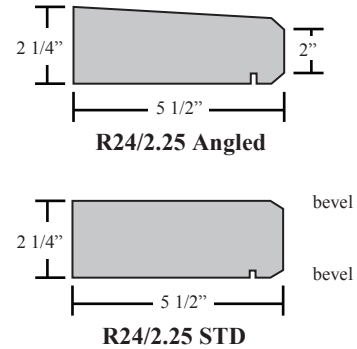
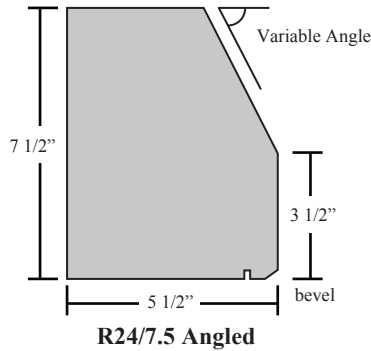
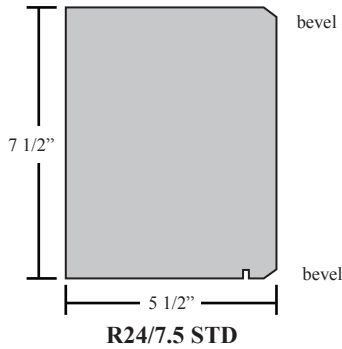

All of the above profiles available in 7 1/2" bed widths.

Cambridge Architectural Sills available in 24" standard lengths.

Cambridge Architectural Sills available in all Cambridge Series Colours, please refer to colour chart and consult your Sales Representative.

EUROPA DESIGNER STONE

- All stone products produced in accordance to CSA Standards
- Europa Stone complements a variety of brick sizes
- Leed compliance

Combinations

100% COMBO

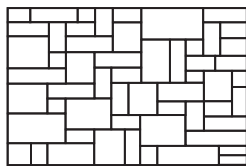

60% COMBO / 40% OF LARGE

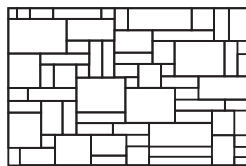

90% COMBO / 10% OF LARGE

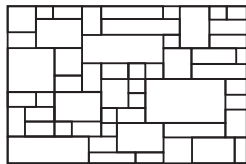

50% COMBO / 50% OF LARGE

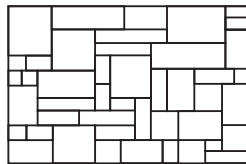

75% COMBO / 25% OF LARGE

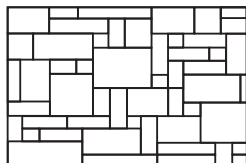

Note: Coverage per cube
80 square feet
(7.43 square meters)

SIZES

Combo

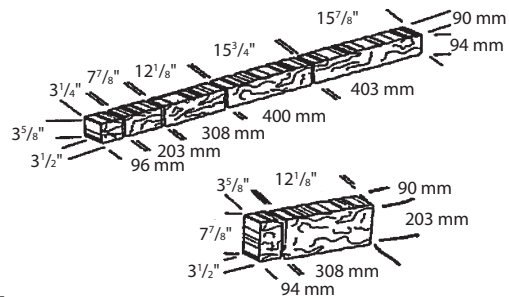

Large

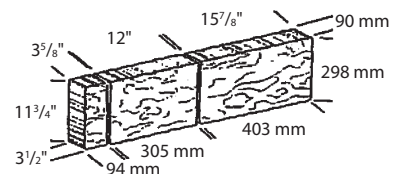

PRICING AND COLOUR SELECTION AVAILABLE UPON REQUEST

SLIGHT VARIANCES IN SHADING MAY OCCUR.



TERMS , CONDITIONS AND ADDITIONAL CHARGES

Cambridge Stone and Architectural blocks are produced to specific order, and require a lead time of four to six weeks minimum, please consult your Sales Representative.

The style, size, colour and quantity must be specified by an authorized Purchase Order.

SLIGHT VARIANCES IN SHADING MAY OCCUR.

Special orders shall be invoiced in full and may not be returned for credit. Undamaged, unopened cubes of stock items may be returned and will be subject to a 50% handling and cartage charges.

All Architectural and Cambridge Series quantities ordered must be purchased entirely, no returns will be accepted.

Prices are based on truck load quantity deliveries.

A set-up charge of \$2000.00 shall be applicable to an order of less than 3,000 units.

Additional quantities for project completion will be priced as a separate order and may incur a \$500.00 set up charge for each size or configuration.

All applicable taxes are extra.

Prices are subject to change and reflect fairly any changes that may occur in applicable freight rates, raw material costs, sales or other taxes payable in respect of the above material, or any of its ingredients. Cartage rates are non-discountable.

ALL PRODUCTS DELIVERED AND "PLACED IN THE WALL" ARE CONSIDERED ACCEPTABLE TO THE OWNER.

Products are manufactured in accordance with CAN-CSA A165.1-M2004 and have a 15 MPa standard strength, based on net area.

For deliveries beyond Metropolitan and surrounding areas of London, Toronto or Kingston, contact any of our office locations.

TERMS ARE NET 30 DAYS. INTEREST ON OVERDUE ACCOUNTS WILL BE CHARGED AT THE RATE OF 2% PER MONTH OR 24% PER ANNUM.

Environmental Industry Levy \$0.05 per unit.

Pallet Charge - \$20.00 each, refundable when returned in good condition.

Plastic bag covers - \$3.50 per cube.

Saw cuts additional \$4.00 per cut.

In the event that our main dispatch telephone line **416.213.7447** does not function please have your Staff placing Orders call the following emergency numbers or call your Sales Representative direct:

LAND LINE 905.888.9934 OR CELLULAR 416.678.8785



CONTACT OUR SALES OFFICE AT:

HEAD OFFICE

5 Cardico Drive, Gormley, ON L0H 1G0

Order Desk 416.213.7447

Toll Free: 1.877.792.5625

Tel: 416.213.7444

Fax: 416.213.7441

LONDON PLANT

1298 Clarke Road, London, ON N5V 3B5

Toll Free: 1.800.265.1592

Tel: 519.455.4741

Fax: 519.453.0732

**FOR DISTRIBUTERS ACROSS CANADA
PLEASE CONTACT HEAD OFFICE**

RICHVALEYORK.COM